

RICHARTZ®

**Good to
know you
have it.**

**MAGAZINE
2026**





“Best design and well-thought-out functionality. **Our motivation for 125 years.**”

Once you own a RICHARTZ® product, you will always carry that good feeling with you. It's good to know that you have it when you need it as a problem solver in everyday life. Use this special connection for successful advertising campaigns and brand collections.

Delight and inspire customers with a product from RICHARTZ®. In the tradition of Solingen, the city of blades, we are now in our fifth generation of producing excellence: unique and aesthetic companions for life, and have been doing so for 125 years!

Discover excellent design combined with innovative functionality and the many possibilities for customizing each RICHARTZ® product for successful use as a promotional item.



Brigitta, Stefan and Luisa Richartz

RICHARTZ® brand products – excellent problem solvers!

One brand. Over 100 national and international awards. For 125 years, we have stood for excellence in design, innovation, and quality. Innovation and responsibility are our mission. That is our standard. Today and in the future.

- Design Innovationen Auszeichnung für hohe Design Qualität Design Zentrum Nordrhein Westfalen



reddot



DESIGN PLUS

design preis SCHWEIZ



RICHARTZ® – a brand of the century.

As a brand of the century, we stand for high-quality pocket tools and functional items like no other company in Germany. Thanks to our 125 years of experience in quality, design, and innovation, we regularly impress the jury with our products and our brand.



Products with personality. From personalities.

Design, quality, service, and innovative strength – it is the dedication of each and every one of our employees that makes the RICHARTZ® brand so strong. Together, we are here for you: competent, reliable, and really friendly too.



Take responsibility!

As a family business, it comes naturally to us to take responsibility. Whether in terms of climate or social issues, we are constantly evolving towards greater sustainability. At the product level, we are continuously improving to minimize emissions and establish social standards – for example, we have introduced the Recycled Claim Standard. This is your guarantee that our products consist of at least 30% recycled metal. We offset any impact that we cannot yet avoid with climate projects run by our partner ClimatePartner.

We are also passionately committed to various local and international campaigns to support children and young people in their development, especially in the areas of health, sports, and nutrition – for example, for the Bogenstraße elementary school in Solingen and the Cambodian Kids Foundation. An e-fleet including charging stations and the Jobrad offer – mandatory for us.



Perfect for biking. Essential for everyday use.

Professional cyclists and casual cyclists know that cycling is much more than just “from A to B on two wheels”: In addition to unpleasant events such as loose screws or breakdowns, there are also wonderful

opportunities to interrupt a tour. For example, to enjoy refreshments along the way! It's good that there is a compact version of our BIKETOOL. With it, you are well equipped for all occasions.

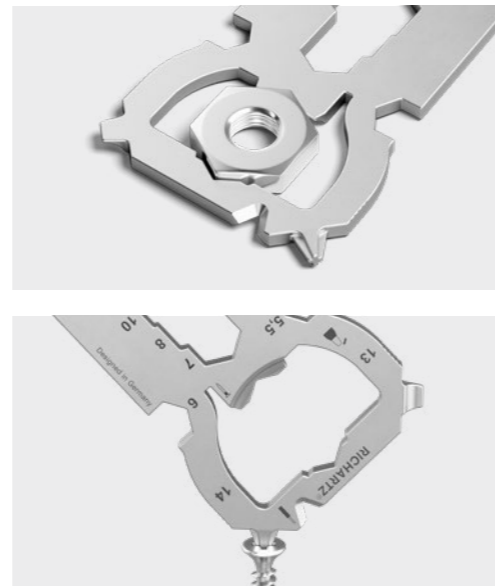

BIKETOOL compact 21+
(available from 1 piece)

BIKETOOL 32+
(available from 1 piece)



NEW

21 functions

32 functions



A real bike doctor: perfect for your key ring. Sensitive on the bike.

Just grab the right hex key and adjust the saddle, valves, or spokes? This first aid kit for cyclists fits easily on a key ring and has already made friends in

many situations: helping stranded cyclists or quickly adjusting the saddle for your own children. And even away from the bike, the tool is a useful helper.

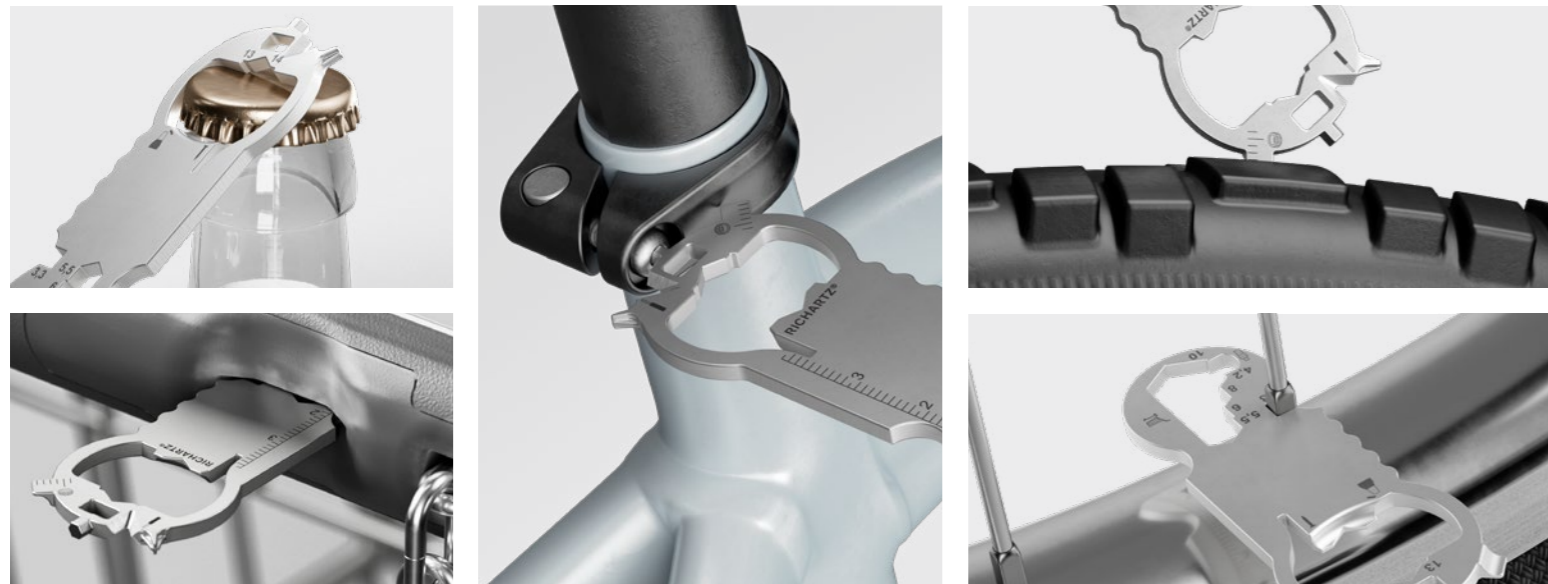

KEY TOOL bike
(available from 100 pieces)

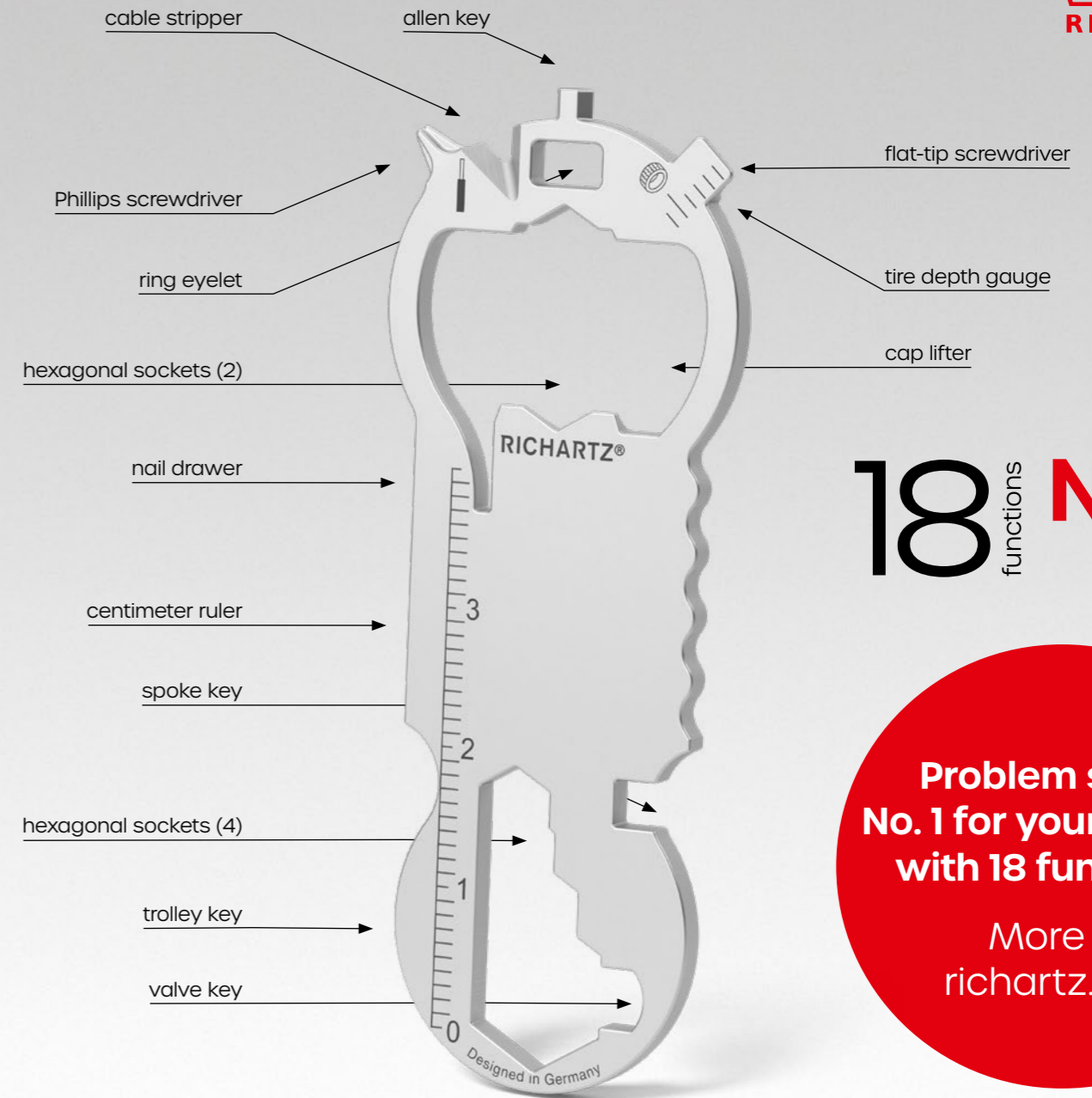

18 functions **NEW**

**Problem solver
No. 1 for your key ring
with 18 functions!**

More at
richartz.com

Smartphone stand and everyday helper for cinema-quality viewing!

A real pro for your pocket. Our KEY TOOLS are known for their versatile Functions, all of which are packed into a tiny format. Our KEY TOOL mobile has 16 of them. This compact problem solver also has a

rubberized smartphone stand that allows you to conveniently place your smartphone or tablet upright. This gives you the best view of movies, pictures, or video calls.



KEY TOOL mobile
(available from 100 pieces)

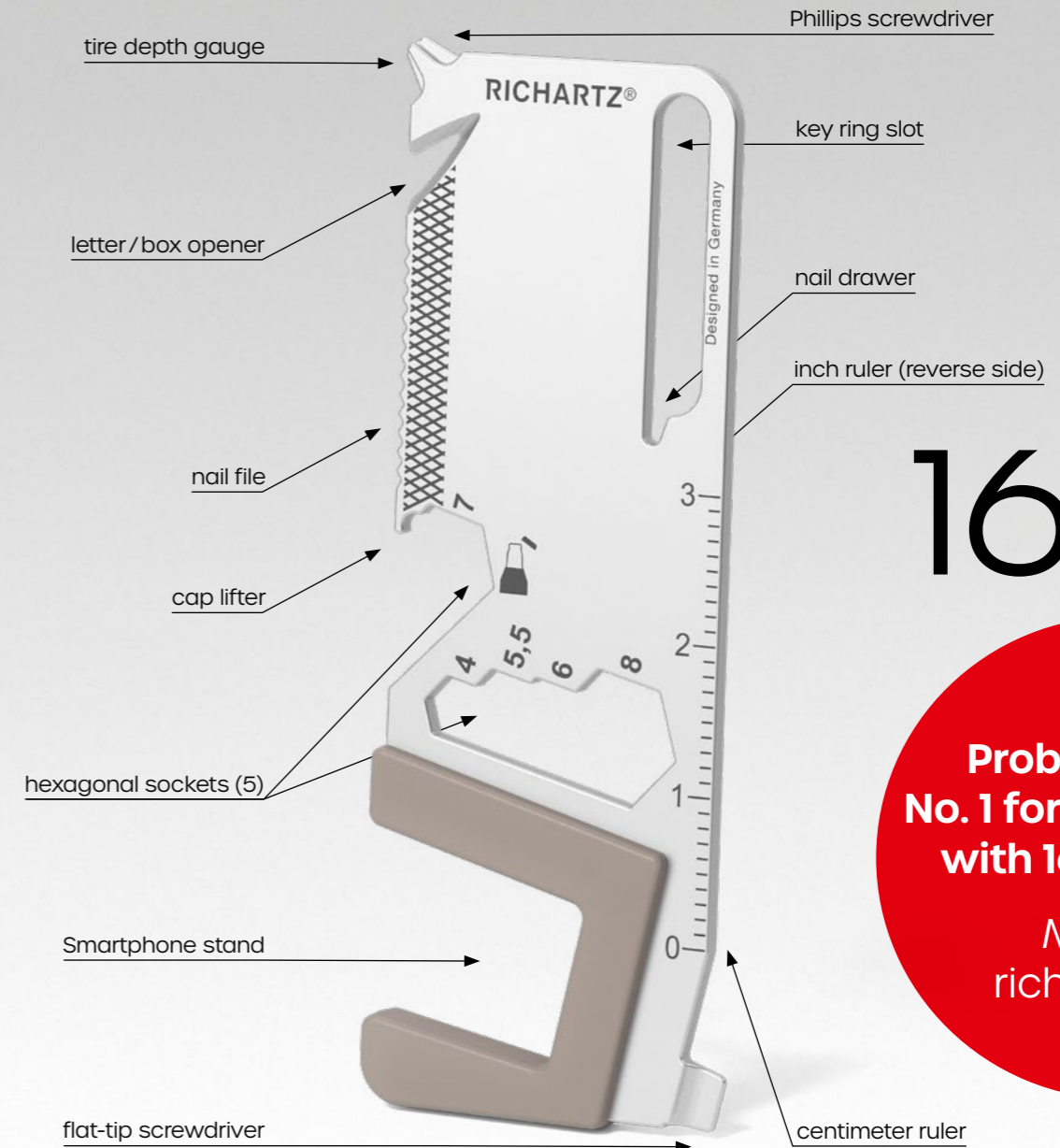

16 functions **NEW**

**Problem solver
No. 1 for your key ring
with 16 functions!**

More at
richartz.com

Spoon, fork, cut, and open: a handy companion for every meal.

When a fork, spoon, knife and bottle opener come together in one compact tool, it clearly looks like a good, complete dinner. With the full-sized spoon and fork with serrated edge, every dish is quickly

polished off and even the accompanying drink is opened in no time at all. From now on, disposable cutlery can be packed away, because SNACKTOOL will be with you for a long time to come!



SNACKTOOL
(available from 100 pieces)



NEW

7
functions



With the **SNACKTOOL** you can forget about **disposable cutlery!**

For shopping, opening bottles, and enjoying a snack now and then.

Innovative - and always happy to be involved

when it comes to enjoyment on the go: With a patented function combining a trolley key and bottle opener with a swivelling fork and spoon, this compact

everyday companion scores extra points. But don't worry: despite its many functions, it fits perfectly on your key ring and looks great too - multiple design awards can't be wrong!

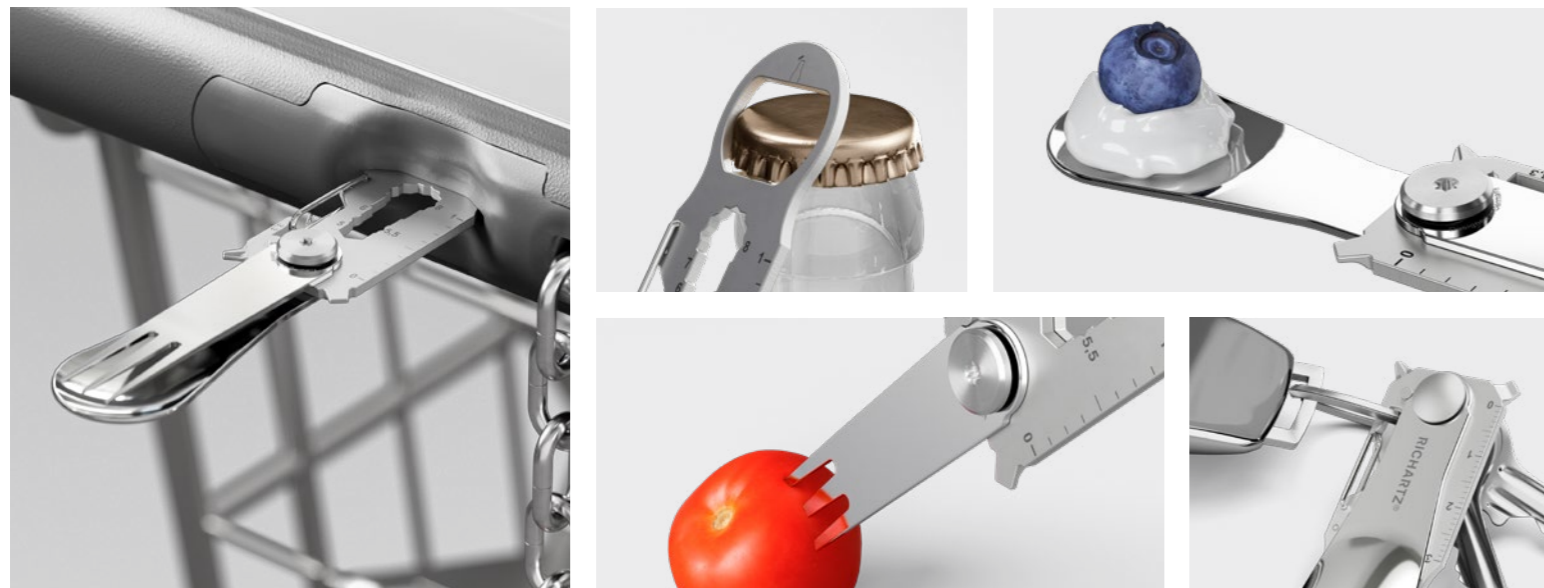

KEY TOOL PLUS snack se
(available from 100 pieces)



NEW

15 functions



reddot winner



NEW:
Polished fork and spoon for perfect eating comfort and easy cleaning.

Top in (vehicle) shape and function for your key ring.

A real eye-catcher: Our SHAPE TOOLS come in the form of vehicles and can do everything you would expect from a pocket tool from RICHARTZ®: open bottles, turn screws, and be ready to hand in everyday life.

And most importantly, the detailed design of the various vehicles makes it easier to reach and inspire target groups. This means users appreciate the compact everyday problem solver even more.

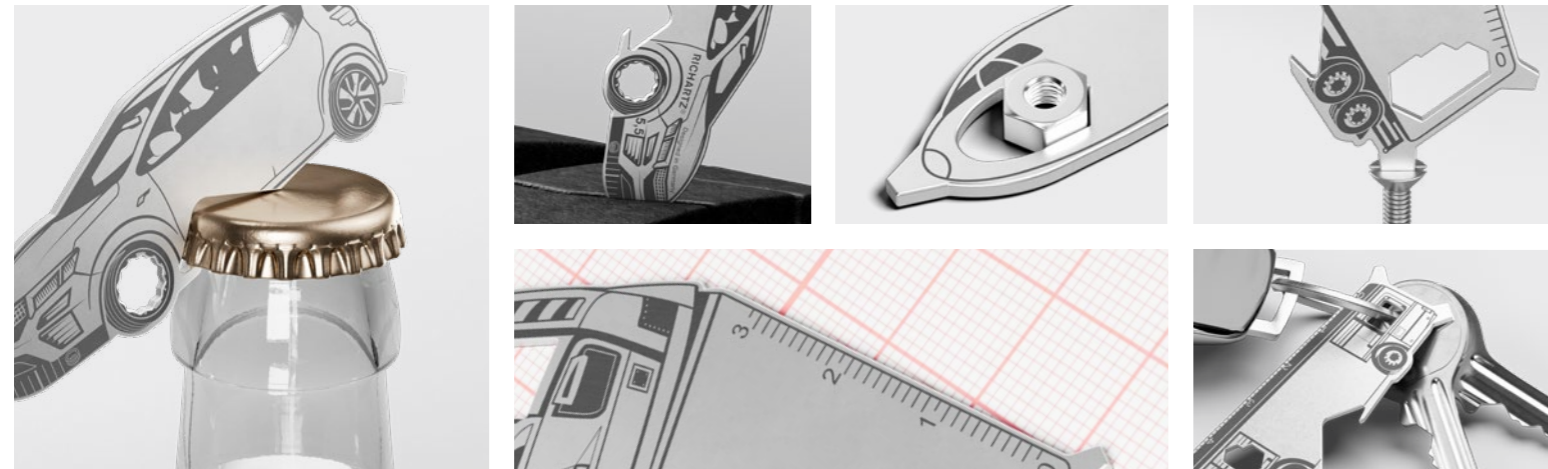

SHAPE TOOL plane, car, truck or bus
(available from 250 pieces)

NEW

All **SHAPE TOOLS** always incl. **individually designed packaging and logo engraving.**



MY KARL and MY FRED – for every industry and occasion

Would you like a karl or fred that perfectly reflects your offer or product? We would be happy to assist you! With our karls and freds featuring special engravings, there are almost no limits to your imagination. You benefit from our proven everyday helpers with many functions and an engraving that effectively showcases your product or brand! And best of all: we take care of the details!

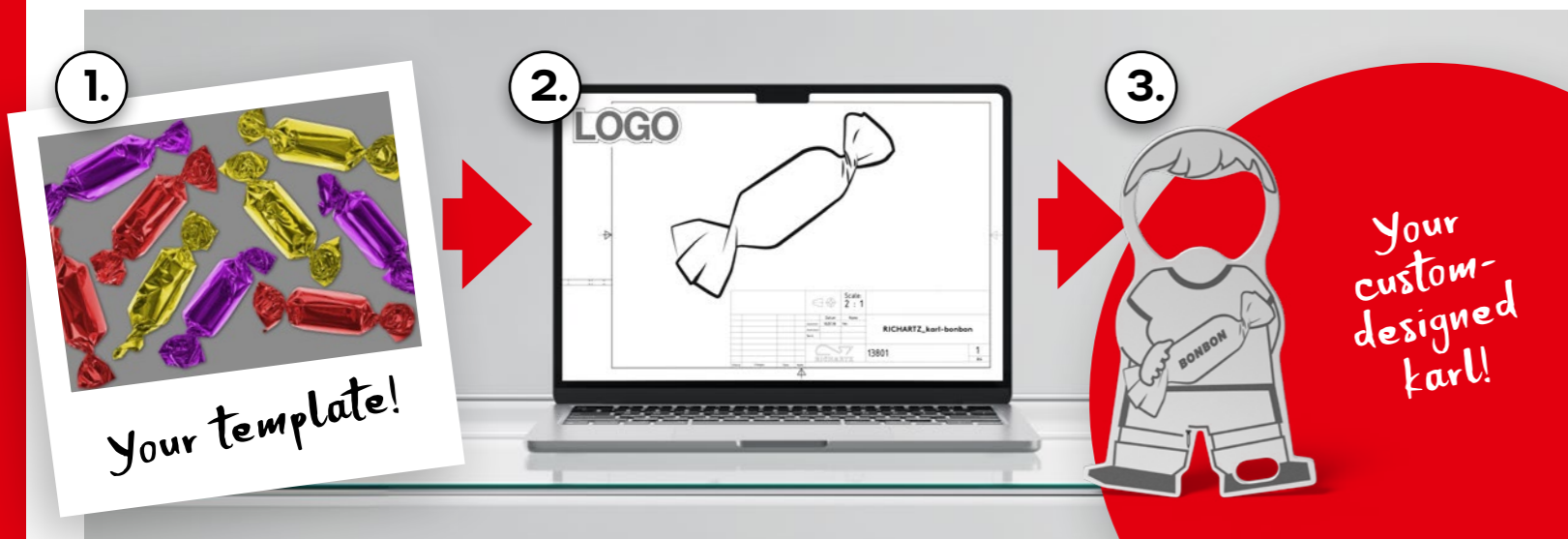

Here's how it works:

1. You provide us with your template.
2. We will create a free layout for you based on a EINKAUFSWAGENLÖSER karl or FLASCHENÖFFNER fred.
3. Once you have approved the design, we will manufacture your customized karl or fred.

Our offer:

- Available **from 3.000 pieces!**
- **Free design proposal and adaptation** to a EINKAUFSWAGENLÖSER karl or FLASCHENÖFFNER fred!
- Includes individually designed **packaging!**

Discover all
product information
about karl and fred!

More at
richartz.com



MY PROFESSIONAL TOOLS - As individual as never before

With customizable handles your promotional items will become real eye-catchers. Whether MY PROFESSIONAL TOOL crafter or rescue - the high degree of customization enhances the product and increases its promotional success. The handles are embossed, making the tactile experience something very special.



Here's how it works:

1. You provide us with your template.
2. We will create a free layout for you.
3. Once you have approved the design, we will manufacture your customized tool.

Our offer:

- Available **from 1.000 pieces!**
- **Free design proposal!**
- Includes individually designed **packaging!**

MY PROFESSIONAL TOOL crafter
(including engraving + embossing
+ individually designed packaging)



MY PROFESSIONAL TOOL rescue
(including engraving + embossing
+ individually designed packaging)

RICHARTZ® MY KEY TOOL – the multitool for your key ring

Your product as a particularly functional solution for everyday problems: With RICHARTZ® MY KEY TOOL, your product or mascot becomes a multitool for your keychain. Precisely manufactured functions, high product quality, and detailed engraving make this everyday helper the perfect companion for everyone!



Here's how it works:

1. You provide us with your template, e.g., as a photo or sketch.
2. We create a free layout for you.
3. Once you have approved the design, we manufacture your MY KEY TOOL.

Our offer:

- Available from **3.000 pieces!**
- **Free design proposal** from the makers of the original RICHARTZ KEY TOOLS®!
- **Free CNC sample** with order!
- Includes individually designed **packaging!**



RICHARTZ® MY KEY TOOL benefits:

- Professionally designed, precise functions, made possible by high-quality manufacturing and fine blanking technology
- Everyday and special functions for different target groups
- Particularly suitable for “technical” industries and industries with high quality standards, e.g., automotive, mechanical engineering



MY SHAPE TOOL – Best value for money for your custom tool!

The perfect custom pocket tool at the best price: MY SHAPE TOOLS, with their ultra-flat design, are ideal for large-scale campaigns such as mailings or on-pack promotions. You receive a truly unique brand ambassador that can be shaped in any way and also boasts a wide range of everyday functions.



Here's how it works:

1. You provide us with your template, e.g., as a photo or sketch.
2. We create a free layout for you.
3. Once you have approved the design, we manufacture your MY SHAPE TOOL.

Our offer:

- Available **from 3.000 pieces!**
- **Free design proposal!**
- **Free CNC sample** with order!
- Includes custom-designed **packaging!**



MY SHAPE TOOL benefits:

- Many practical functions for everyday use
- Ultra-flat multi-tool, particularly well suited for mailings and on-pack promotions
- All-in-one solution for targeted promotional items



RICHARTZ® – a brand of the century



RIMA EN 010126



design
preis
SCHWEIZ



DESIGN
PLUS



reddot



German
Design Award

- Design Innovationen
Auszeichnung
für hohe Design Qualität
Design Zentrum
Nordrhein Westfalen



125 YEARS
RICHARTZ®
THE ORIGINAL

richartz.com

All products are protected by
law. Technical improvements
reserved.